



Register Your  
Warranty



Digital Install  
Guide

# ULTIMATE™

## INSTALL GUIDE

### MINI AQUA HE / MIDI HE / MASTER HE / MATRIX HE

This symbol opposite means that according to United Kingdom and European Union member countries laws and regulations your product and/or its battery shall be disposed of separately from household waste.

When this product reaches its end of life, take it to a collection point designated by local authorities. The separate collection and recycling of your product and/ or its battery at the time of disposal will help conserve natural resources and ensure that it is recycled in a manner that protects human health and the environment.

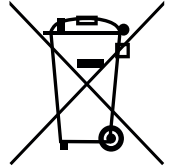

#### / A. PLANNING THE INSTALLATION

- Always observe the water byelaws.
- Ensure there is only one rising main.
- Make sure you have allowed space for access to the unit for salt filling and for any possible maintenance in the future.
- Check the water pressure and locate the rising main, a drain facility and a power supply. Be aware of condensation occurring in warm environments.

#### / B. SITING THE SOFTENER - see Fig 1 Page 2 for more info

- Where possible, this should be close to the rising main.
- Tee off for mains water supply to outside tap if applicable.
- Rapid-Fit bypass has a 3/8" speed fit connection for flexi tube connection to a dedicated drinking water faucet. Monarch faucet and 5mtr length of 3/8" tubing code is MW38CFK.
- The distance between the softener and the drain should be as short as possible, to ensure that both the drain and the overflow are not subject to freezing, or over 120°F/49°C.
- If siting the softener within a kitchen cupboard, loft etc. ensure that the base/floor is adequately supported.
- If the softener is being installed in your loft, 1st, 2nd floor etc, it is strongly recommended to house the softener within a 25-gallon plastic tank and insulate well. Monarch take no responsibility of any water damage etc if this recommendation is not applied.
- The overflow on the plastic tank should be below the overflow of the softener and a minimum of 3/4" in size. Failure to install the softener in a suitable tank will void the warranty.

#### / C. CHECK VALVE

Domestic Ion exchange water softeners are in fluid category 2. The Rapid-Fit bypass incorporates a high flow check valve in accordance with this requirement. All other applications require a double check valve.

#### / D. DRINKING WATER FACILITY

The Regulations require that 'All premises supplied with water for domestic purposes shall have at least one tap conveniently situated for the drawing of drinking water'. Drinking water must comply with the Water Supply (Water Quality) Regulations 2000, which stipulate a maximum limit of 200 mg/l (milligrams per litre) for sodium. The Department of Health recommends that this sodium limit should not be exceeded for infant feed preparation and for those individuals on a medically supervised low-sodium diet. The provision of an unsoftened drinking water tap is essential where the hardness of the public supply and its sodium content as supplied would result in the softened water exceeding 200 mg/l sodium limit. For ion exchange softened water, this limit will be exceeded where the water is extremely hard, i.e. above 400 milligrams per litre as CaCO<sub>3</sub> (assuming zero sodium in the public supply).

#### / E. MATERIAL CHECK LIST

- The softener includes a 15mm Monarch Rapid-Fit bypass installation kit for a conventional system (storage tanks in roof).
- For Combi boilers you will need additional Maxflow Hoses-ref MFH006.
- For pressurised systems (22mm pipe work) simply remove the reducers within inlet/outlet connection on the Rapid-Fit bypass and use Maxflow hoses.
- For 28mm supplies a full upgrade for the softener is available - details on request - Ref M28UGHE. 28mm is not suitable for the Mini Aqua HE.

## / F. WATER PRESSURE TEST

- It is IMPORTANT that a pressure check is carried out.
- Low and high pressure can result in either damage to, or failure of the unit.
- If daytime static water pressure\* exceeds 3.5 bar (50psi) a 5 bar (70psi) pressure limiter should be fitted. \*50psi daytime pressure can reach nearly 100psi at night!
- Minimum dynamic pressure must exceed 1.5 bar.
- If in any doubt please call us on +44 (0) 1986 784 759

## / G. INSTALL RAPID-FIT BYPASS

Form an installation as per Fig 1.

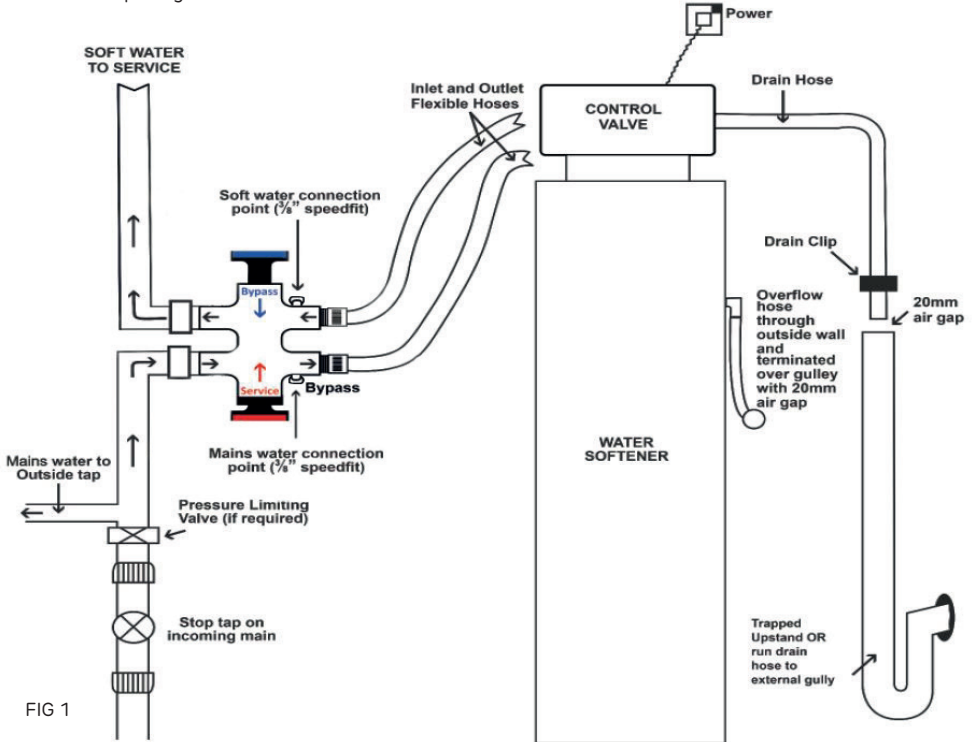

FIG 1

## / CHECK LIST

- Water pressure 1.5 – 5 bar (20 – 70psi)
- Access to incoming water supply
- Access to 3 pin socket
- Access to drain
- Installation preferably on an outside wall for the overflow
- Easy access to fill unit with salt

## / RAPID-FIT BYPASS INSTALLATION INSTRUCTIONS

Direction arrows are embossed on the bypass as follows;

SUPPLY IN - is hard water supply in from mains

SUPPLY OUT - is soft water supply back to property

TO UNIT - is mains hard water from bypass to softener inlet via flexi hose

FROM UNIT - is soft water from the softener outlet back to bypass via flexi hose

Every Rapid-Fit bypass comes with the following;

1. 2 x Stainless steel hoses
2. 2 x 24.6mm fibre washers (inserted)
3. 2 x 2mm x 3/4" FI brass adaptors
4. 2 x 22mm x 15mm reducers



- For Combi boilers upgrade hoses to Maxflow hoses - see image far right.
- For 22m Unvented/Pressurised systems, upgrade to Maxflow hoses and do not use the 22mm x 15mm reducers.
- For 28mm applications, upgrade to 1". Code is M28UGHE if ordered with softener. For upgrade after softener order, code becomes M28UGLOHE.

### Connection of brass adaptor (22 x 3/4 FI & 28 x 1" FI) to Rapid-Fit bypass:

1. Fibre washers are pre inserted against shoulder inside brass female thread - Fig A. **IMPORTANT** - Do not use 3/4" industry standard washers here.
2. For additional security, Fernox LS-X or Loctite SI 5331 may be used (see image above). Simply apply to male thread of noryl bypass adaptor and to inside of female thread of brass fitting - Fig B. In all cases, fibre washer must be used.
3. Tighten male noryl connection into brass adaptor solidly up against fibre washer - Fig C. Remove any excess sealant inside brass/noryl adaptor assembly.
4. Place assembled connection back into bypass and fix with clip - Fig D.
5. Run hard water mains supply pipe to SUPPLY IN connection
6. Repeat 1-5 above for soft water mains supply to SUPPLY OUT connection.

### / IMPORTANT

Noryl bypass adaptor in an 'o' ring seal within main bypass body, therefore it may be easier to connect brass fitting to adaptor if adaptor is remote from bypass. To remove adaptor, simply remove holding clip. Do not use heat on any connection that may affect the bypass.

Noryl bypass adaptor in an 'o' ring seal within main bypass body, therefore it may be easier to connect brass fitting to adaptor if adaptor is remote from bypass. To remove adaptor, simply remove holding clip. Do not use heat on any connection that may affect the bypass.

FIG A



FIG B



FIG C



FIG D



### / H. INLET & OUTLET CONNECTIONS - See Fig 2

- Remove both salt lid and main cover to access inlet and outlet connections.
- Remove grey retaining clips and also BSP connection points. Connect hoses to male BSP connection points, tighten to seal, then reinsert BSP connection points back into valve body. Fit grey clips. The connection points are designed to rotate once inserted in valve body. This removes any stress/ pressure placed upon the angle/direction of hoses when connecting same to Rapid-Fit bypass.
- We recommend you fit the elbow end of the hose to the inlet/outlet connection points on the softener. Under no circumstances use washing machines hoses or plumb the softener in solid copper pipe.

FIG 2



INLET    OUTLET

**Black barbed elbow**

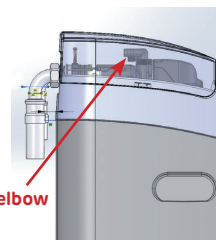

FIG 3

### / I. DRAIN CONNECTION

- 2.5mtrs of white low pressure drain hose is supplied with the unit. This is to be used for both the drain and overflow. The **drain connection** is the **black barbed elbow** under the rear top cover, see Fig 3. To remove rear top cover, simply slide forward out of fixing, and lift off. Fix drain hose to black barbed elbow with jubilee clip (supplied).
- Run the drain hose to either an upstand or an outside drain. A minimum air gap of 20mm should exist at the end of the drain line.
- If you need to extend the drain hose, this can be done by connecting to a 15mm copper tube for a maximum run of 4 metres, with a minimum daytime pressure of 40 psi. Over 4 metres please use 22mm (or similar) copper tube.
- Ensure that the drain hose is adequately fixed to the copper pipe.
- The drain hose must not dip or be kinked in any way, as this will lead to an overflow of the machine.
- UPHILL? The white flexible drain hose can run uphill internally, for a maximum of 3 feet, with a minimum water pressure of 40 psi.
- Softened water will have no adverse effect on a septic tank.
- Under no circumstances should the softener drain and overflow share the same pipe. This could lead to foul smells entering the salt cabinet from the main drain via the overflow. Also if the common drain ever gets blocked, the regen water can re-enter the softener via the overflow pipe.

#### / J. OVERFLOW CONNECTION - IMPORTANT

- The hose for the overflow should be cut from the white low pressure hose supplied with the unit.
- The overflow connection is the 1/2" hose spigot on the rear right hand corner of the cabinet – no jubilee clip required.
- The overflow must be run downhill and terminate immediately through an outside wall without kinks or restriction.
- A 22mm (or similar) copper protective sleeve through the outside wall will help prevent kinking of the hose.

#### / K. TEST INSTALLATION FOR LEAKS

Place Rapid-Fit bypass in Bypass position by pushing plunger as per directional arrow - see Fig 4 on page 5. Open mains stopcock slowly to flush the new pipe work. This can be done using a 'soft' mains tap i.e. utility room cold tap or wash hand basin in a bathroom. Check all connections for leaks.

#### / L. ELECTRICAL CONNECTION

With the power off, connect the transformer – supplied – to a continuous electrical supply. Push the flying lead from the transformer into the adaptor on the lead coming from the controller.

#### / M. OBTAIN YOUR WATER HARDNESS



- These instructions apply to the enclosed test kit only.
- Run hard water for approx. 1 minute and rinse the test tube well.
- Fill the test tube up to the 10ml level. Add 2 drops of the dark solution and mix gently. If the water sample contains hardness it will turn red.
- Add the dark solution in batches of 5 drops, holding the dropper bottle at 45 degrees.
- Mix gently after each 5 drops.
- Count the drops needed until the colour of the sample in the test tube changes from a dark red to a dark blue/green.
- You need this figure for when SET WATER HARDNESS as per P overleaf.

#### / N. SETTING THE ELECTRONIC CONTROLLER

- Turn on power and the softener display will say WELCOME.
- The Display is a 2 line display showing both the Model No and also Time and Hardness. The Time and Hardness will alternate every 10 seconds.
- To finalise commissioning of the softener, you need to set both Time (24hr clock in hours and minutes) and the water Hardness as determined by the amount of drops in your water hardness test.



#### / O. SET TIME OF DAY

- Wait until display says Time of Day. If Time of Day is correct, skip to P. SET HARDNESS.
- Press Up button to show flashing Hours. Please note it is a 24hr clock.
- Press Up or Down button to set Hours.
- Press  to confirm Hours.
- After confirming Hours, display will show minutes flashing.
- Use Up and Down button to set Minutes.
- Press  to confirm Minutes.

Time: 8:00

#### / P. SET WATER HARDNESS

- Wait until display changes to Hardness.
- Press Up Button to show Set Hardness with no flashing.
- Use Up Button to set number as determined by your water hardness test.
- Press  to confirm setting.

Hardness: 10

UP TO 30 DROPS	ADVANCE ELECTRONIC DISPLAY TO 30 (REC MIN SETTING)
31 -35 drops	advance electronic display to 35
36 - 40 drops	advance electronic display to 40
41 - 45 drops	advance electronic display to 45
46 - 50 drops	advance electronic display to 50

FIG 4

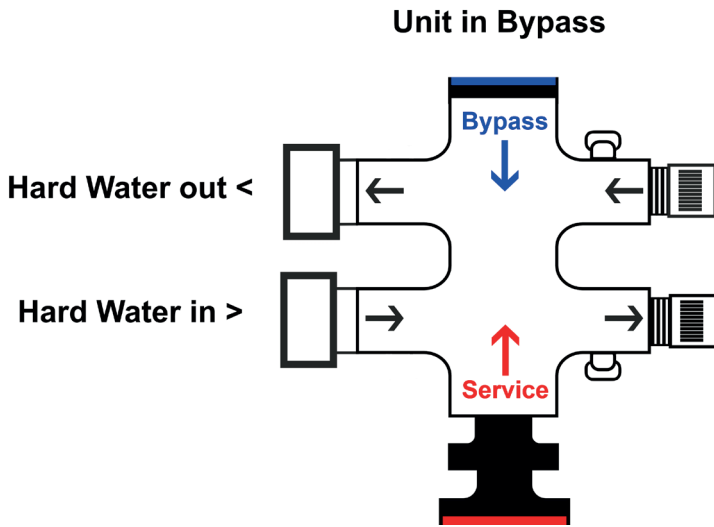
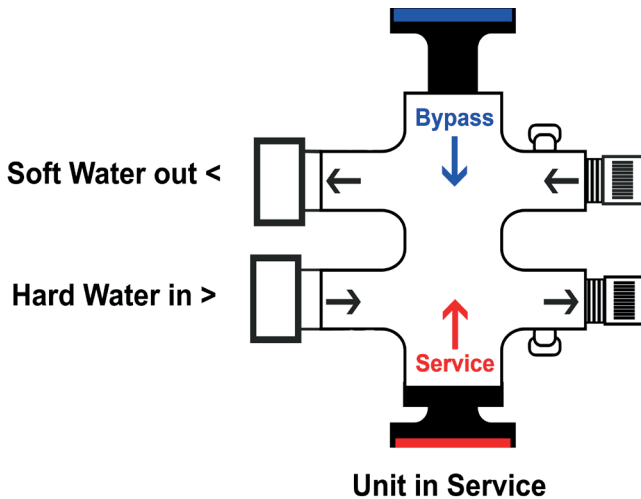

FIG 5



- You have finished the programming.
- The display will now automatically revert back to the alternating display.
- If at any time you need to reset any figure, wait until the display changes to the relevant setting and then re-programme as required.

#### / Q. FLUSH SOFTENER - IMPORTANT

- Place Rapid-Fit bypass in Service position by pushing plunger as per directional FIG 5.
- Check for leaks.
- Leave a soft mains tap e.g. bathroom wash hand basin, to run for a minimum of 5 minutes to purge any air and 'resin dust' from the softener (resin dust may appear orange in colour).
- DO NOT fill salt compartment higher than the bottom of the lift handles moulded into the sides of the cabinet. Ref to diagram page 6. On GS models we do not recommend the softener is filled more than 2/3rd full to prevent unnecessary pressure on cabinet walls. The water softener is a 'wet salt softener' which will set its own level of water in the cabinet.
- On all MiniAqua/Midi/Master/Matrix HE models, add 1 litre of water to the salt compartment on initial installation only. For GS models add 2 litres.  
If at any time you see excess water in the salt compartment going down the overflow, please call our service team on +44 (0) 1986 784 759.

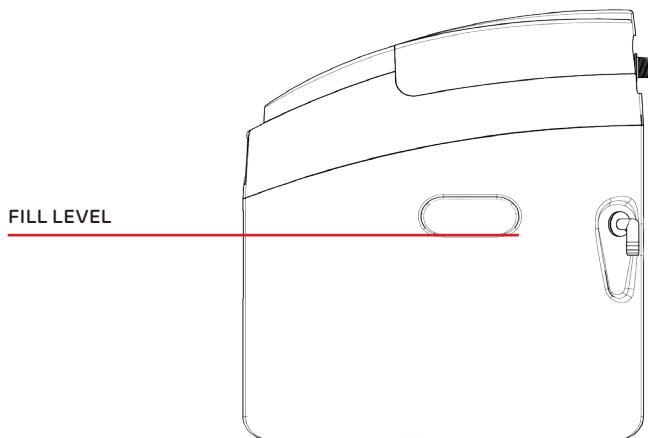

#### / R. EXTRA REGENERATIONS

- To start an automatic regeneration, press the left hand button and release, the display will count down from 15 to zero. If at any time you wish to cancel the count down, simply press  again.
- An automatic regeneration will start shortly.

#### / S. BLENDING CONTROL – Blue/Green Stains

- All our water softeners are factory set to produce water that is 100% soft. If you require slightly blended water – recommended on Combi/Condensing Boilers and in areas of hard water that have a green/blue build up in the scale – open blender bypass (Fig 6) on left hand side of softener control valve slightly – until it takes 6/7 drops of the dark liquid to get a red to green colour change, as per the original water hardness test.

#### / NOTE

This blended water setting can only be done when the softener is in Service.



FIG 6

#### / FURTHER INFORMATION

- Please do not remove the mesh bag that surrounds the brine draw. The bag acts as a filter to any sediment or unwanted particles.
- This softener uses tablet salt only.
- Do not worry if your softener regenerates during the day. This is the Self Protect Programme initiating an additional mini regeneration, as the softener does not have enough soft water to last you until the next programmed regeneration of 2am.
- A regeneration can last between 51 and 92 minutes depending on the model. During this time the softener goes into hard water bypass, ensuring a continuous supply of water.
- A Normal regeneration is programmed to 2am, a time when little, if any, water is being used.
- To change the regeneration time, simply offset the Time Setting i.e. to have the unit regenerate 2 hours later, set clock 2 hours slow- see O.
- To ensure the softeners continuous operation, please do not let the salt drop below half way down in the cabinet.
- Moving the softener. When moving the softener, please ensure that there is no water in the salt compartment to prevent accidental ingress into working parts of the softener. Failure to do this may cause warranty to become void.

#### / GOING ON HOLIDAY?

- Fig 5 shows the Rapid-Fit bypass in the Service position. This is the normal operating position.
- We highly recommend you bypass your softener and turn off the electrics when going away on holiday.
- Simply press the central plunger from Service to Bypass as (See Fig 4) shown by the arrows on the unit and confirmed by the diagrams below.
- Reverse the above and place bypass back in Service upon your return.
- Reset time (if necessary) by reverting to Set Time of Day.
- Activate a manual regeneration by pressing left hand button  on controller. Display will countdown from 15 to zero. Please be aware that during the regeneration, the softener goes onto automatic hard water bypass, so it is recommended to use washing machine etc after the regeneration is finished when full soft water will resume.

## / MONARCH WATER DOMESTIC WATER SOFTENER WARRANTY - Effective March 2023

This water softener is fully covered by 7 year parts and 2 years 'at home' labour warranty for installation within the hard water regions of mainland England, Scotland and Wales (including Isle of Wight) from date of original purchase. Installations outside this area are automatically covered by a 7 year parts only 'exchange' warranty.

PLEASE NOTE - This warranty has the following conditions, and is not covered by the following.

1. Damage caused by high water pressure, we strongly recommend a 5 bar water pressure limiting valve on the inlet to your water supply, where daytime water pressure exceeds a static pressure of 3.5 bar (50psi).
2. This water softener is suitable for a mains water supply only.
3. The majority of debris in water is caused by local authority work on the water main. If notified in advance, by your local water authority, please put your softener onto 'bypass', see Fig 4 on page 5.  
For Bypass: Press central plunger on Rapid-Fit bypass as per directional arrow towards Bypass.  
For Normal Service: Press central plunger on Rapid-Fit bypass as per directional arrow towards Service. See Fig 5 on Page 5.
4. Callouts due to incorrect installation. If you have any queries when installing your softener, please call us on +44 (0) 1986 784 759.
5. The wrong type of salt used and also the softener being allowed to run out of salt. NOTE: In all cases use TABLET SALT ONLY.
6. The use of any other hoses than those that are classified as food grade. Under no circumstances use washing machine hoses.
7. The build-up of salt fines in the bottom of the salt compartment. Although Monarch recommends Ultimate tablet salt, it recognises this is not always available, therefore please note it is the customers' responsibility to ensure the salt is of good quality and condition when used.
8. The effect of aggressive water, the degradation and/or blinding of resin and/or chlorine attack on resin.
9. Under no circumstances hard plumb in the softener in solid copper.
10. The installation kit (including Rapid-Fit Bypass) is only covered by the OEM twelve-month parts 'exchange' warranty only.
11. Repairs necessary due to incorrect installation, misuse or damage are not covered by the warranty. Any appointments missed, or not cancelled with at least 24 hours' notice; Monarch Water reserve the right to make a charge to cover their costs and will be charged at our standard rates.  
In the unlikely event of a fault, put the softener onto Bypass, see 3 above ref 'For Bypass' until an engineer calls.
12. Please note that any callouts within the warranty period that are due to external influences affecting the operation of the softener, may incur a charge.  
The above does not affect your statutory rights.

## / SERVICE CARE

The manufacturer of your water softener includes 55+ years of manufacturing experience, to give you a water softener that is arguably the most reliable on the market today.

One of the aspects incorporated into the manufacture of your softener is 'Prevention is better than cure'.

Monarch strongly recommends a service once every 2 years to ensure optimum continued performance.

We will of course inform you when this service is due and arrange a convenient time for our engineer to call.



Therefore please ensure that you register your warranty with us at [monarchwater.co.uk/registration](https://monarchwater.co.uk/registration) or scan this QR code:

## / IMPORTANT

Monarch recommends Ultimate™ Tablet salt in all their water softeners.

## / MONARCH NATIONAL SERVICE COVERAGE AREAS

All postcodes within the hardwater areas of mainland England, Scotland and Wales (including the Isle of Wight) are automatically covered by a parts and labour warranty as set out in the relevant brochure for the individual model/range.

## / IMPORTANT

Water softeners sold outside of the hardwater areas of mainland England, Scotland and Wales (including the Isle of Wight) are to be strictly covered by a parts only 'exchange' warranty as determined by the model/range of softeners i.e. Unit with 7 years parts.

All parts sent back to Monarch are at the expense of the sending parties. All repaired or replaced items will be returned to the sender on a no charge basis whilst covered by the parts exchange warranty.

Once the parts exchange warranty has expired, Monarch reserves the right to make a charge for any postage/delivery, labour and parts charges that is deemed necessary.

Monarch will endeavour to keep these charges at the lowest cost whenever possible.

+ 44 (0) 1986 784759  
monarchwater.co.uk  
info@monarchwater.co.uk



#### / HINTS AND TIPS ABOUT YOUR NEW WATER SOFTENER

1. Make sure the electricity supply is not turned off, unless on holiday mode.
2. Please ensure that any appliances (washing machine etc.) used during 'Economy 7' time, do not begin their cycle between 11pm and 5am.
3. To ensure the highest efficiency is obtained, it is recommended that you top up the unit with tablet salt on a weekly basis, it is a lot easier to remember than monthly! DO NOT fill salt compartment higher than the lift handles moulded into the sides of the cabinet. Ref to diagram on page 6. Filling your softener on a weekly basis is a lot easier to remember than monthly! Never let the salt go below half way down the cabinet, as this will affect the performance of the softener. IMPORTANT: The quality of your salt will help determine the operating efficiency and reliability of your softener. Monarch strongly recommend its own Ultimate Tablet Salt. However, if your local outlet does not have this in stock, please ensure the salt used complies with BS EN 973 Grade A standards.
4. Power Cuts. Simply reset the time as per your instructions – see section O ref SETTING THE TIME.
5. Bath and shower surfaces will become smoother – be careful, in particular the young and infirm – why not buy a bath mat?
6. Cut washing powder down by at least a 1/3rd or you will go into a kitchen/utility room full of suds!
7. Soft water will become available throughout your system in varying time spans. Conventional systems (tanks in your roof) will take anything from 4- 10 days, whilst mains fed Pressurised Systems will give soft water within 2-3 days.
8. Dishwashers – On most installations the dishwasher is to be connected to the soft water. We recommend that you continue to add a small amount of salt to the appliance as before, as this helps the salt holder in the appliance stay clean. We do not however recommend that crystal glass, solid silver or silver plated items are washed in your dishwasher as etching may occur. Less dishwasher liquid may be required and in certain cases this will also apply to rinse aid. On dishwashers connected to hard water, you should continue to put salt into the dishwasher's own softener. If in any doubt if your machine should have either hard or soft water, please contact your dishwasher manufacturer, but remember they want to sell you spare parts to replace those that get scaled up!
9. Steam Irons – We do not recommend the use of soft water in your steam iron as most are designed for hard water and to be periodically de-scaled. Alternatively please use de-ionised water.
10. Outside Tap – It is recommended to leave your outside tap on mains hard water. Additionally, in the wintertime we recommend that this tap is isolated via an internal valve to prevent freezing.
11. Existing scale – Soft water will immediately begin to de-scale your pipes and appliances. Your hot water cylinder will take longer to de-scale than your pipe work; therefore you may notice different levels of soft water for some time whilst the system is de-scaling. This is particularly noticeable in your bath and shower.
12. Every boiler has two sides to its operation. The radiators are classified as the 'primary system' and the hot water through the taps etc is called the 'secondary system'. All the benefits of soft water are enjoyed in the secondary side of the system, i.e. cold and hot water in your shower, bath, toilets, appliances, your hot water cylinder etc. The majority of boilers primary side are designed to be used with hard water. Therefore in compliance with the HHIC and boiler manufacturer guidelines, place softener on bypass and fill primary system (radiators) with hard water and the appropriate inhibitor. The inhibitor is designed to keep the radiators operating at maximum efficiency. Once the radiators are filled with hard water, place your softener back into service. This will return the remainder of the system (secondary) to soft water throughout.
13. Accumulators – please ensure that the softener is installed on the outlet of an accumulator.

Register your  
warranty here



EVOLUTION SINCE 1964